

# Glass Segmentation using Intensity and Spectral Polarization Cues

Haiyang Mei<sup>1</sup> Bo Dong<sup>2,\*</sup> Wen Dong<sup>1</sup> Jiayi Yang<sup>1</sup> Seung-Hwan Baek<sup>2,3</sup> Felix Heide<sup>2</sup>  
Pieter Peers<sup>4</sup> Xiaopeng Wei<sup>1,\*</sup> Xin Yang<sup>1,\*</sup>

<sup>1</sup> Dalian University of Technology <sup>2</sup> Princeton University <sup>3</sup> POSTECH <sup>4</sup> College of William & Mary

[https://mhaiyang.github.io/CVPR2022\\_PGSNet](https://mhaiyang.github.io/CVPR2022_PGSNet)

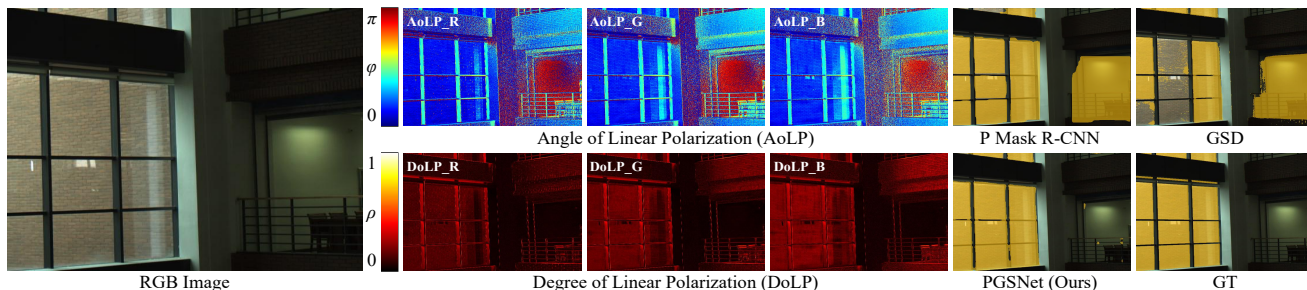

Figure 1. Glass segmentations obtained with the RGB-only method of Lin *et al.* [21] (GSD) and the monochromatic polarization method of Kalra *et al.* [17] (P Mask R-CNN) compared to our glass segmentation network. The detected region is indicated by the orange masks. Both prior methods fail to cleanly separate the non-glass regions with similar appearance. In contrast our method accurately segments the glass region with the help of the spectral polarization cues.

## Abstract

Transparent and semi-transparent materials pose significant challenges for existing scene understanding and segmentation algorithms due to their lack of RGB texture which impedes the extraction of meaningful features. In this work, we exploit that the light-matter interactions on glass materials provide unique intensity-polarization cues for each observed wavelength of light. We present a novel learning-based glass segmentation network that leverages both trichromatic (RGB) intensities as well as trichromatic linear polarization cues from a single photograph captured without making any assumption on the polarization state of the illumination. Our novel network architecture dynamically fuses and weights both the trichromatic color and polarization cues using a novel global-guidance and multi-scale self-attention module, and leverages global cross-domain contextual information to achieve robust segmentation. We train and extensively validate our segmentation method on a new large-scale RGB-Polarization dataset (RGBP-Glass), and demonstrate that our method outperforms state-of-the-art segmentation approaches by a significant margin.

\* Xin Yang (xinyang@dlut.edu.cn) and Xiaopeng Wei are the corresponding authors. Xin Yang and Bo Dong lead this project.

## 1. Introduction

Autonomous robots, aerial drones, and self-driving vehicles rely on an array of sophisticated sensors and algorithms that enable them to sense and understand their environment. However, objects with transparent or semi-transparent materials remain an open challenge for existing scene understanding methods. In contrast to opaque materials, transparent materials typically lack texture, and their complex dynamic appearance depends over various local and global properties, ranging from light-matter interactions (*i.e.*, reflection, refraction, and transmission), object shape, and background, resulting in out-of-distribution observations that are difficult to model.

The majority of existing segmentation methods for transparent materials leverage either contextual information [27, 41] or rely on boundary detection [11, 40]. Both strategies operate in the RGB domain where the interactions between light waves and transparent materials only produce weak cues. A few works have investigated leveraging richer representations of light-matter interactions for transparent material recognition, such as light fields [23, 34, 43] and polarization [17, 19, 20, 37, 39]. However, these methods also rely on strong assumptions on the target size and reflectivity, or assume restricted capture conditions.

In this work, based on that glass materials often provide a distinctive spectral-polarimetric response, we lever-

age both trichromatic intensity and trichromatic linear polarization cues from images captured in-the-wild to infer rich contextual information for robust transparent material segmentation. Linear polarization cues, described by the degree of linear polarization (DoLP) and the angle of polarization (AoLP), can provide strong cues [17] for transparent object segmentation (Figure 1) and can be thought of as intrinsic object textures for transparent materials. However, depending on the view and lighting conditions, these cues might not be equally informative over all three wavelengths, or even confound valid RGB intensity cues. To address these challenges, we design a Polarization Glass Segmentation Network, which we dub “PGSNet”, that utilizes an Early Dynamic Attention (EDA) module to dynamically estimate three global scaling weights for each channel of the trichromatic DoLP and AoLP. The weighted DoLP and AoLP, together with the RGB image features, are fed into a Conformer [31] backbone network to extract robust global and local features. The multi-modal local features are then fused by a Dynamic Multimodal Feature Integration (DMFI) module guided by the global features, and subsequently used by a Global Context Guided Decoder (GCGD).

To train PGSNet, we introduce a large-scale RGB-Polarization dataset, dubbed RGBP-Glass, which contains 4,511 manually annotated RGB intensity images and the corresponding trichromatic (*i.e.*, RGB) AoLP and DoLP images. To ensure diversity, we capture the images in the RGBP-Glass dataset from different real-world scenes that have significant variations in location, type, shape, color contrast, and light conditions.

We demonstrate the effectiveness of our approach and show the importance of multi-chromatic polarization cues for glass segmentation. Our extensive experiments show that our method significantly outperforms competing methods. We make the following contributions

- the first learning based method to exploit multi-chromatic polarization cues for glass segmentation on photographs taken in-the-wild;
- a novel attention-based glass segmentation network that dynamically fuses RGB and multi-chromatic polarization cues; and
- a new and unique large-scale RGB-P glass segmentation dataset.

## 2. Background and Related Work

**Polarization.** Light is composed of transverse waves of electric and magnetic fields, and its polarization state describes the orientation of the transverse electric field. Within a non-zero finite time of observation, this orientation can be randomly distributed (unpolarized), biased toward a single direction (linearly polarized), or in between the two extremes (partially linearly polarized). We focus

our discussion on linear polarization supported by emerging polarization-array CMOS sensors, and omit polarization states such as circular and elliptical polarization. Typically, these ‘polarization’ cameras record four linear polarization states of light:  $I_{0^\circ}$ ,  $I_{45^\circ}$ ,  $I_{90^\circ}$ , and  $I_{135^\circ}$ , where  $I_x$  describes the image captured by a linear polarizer at the angle  $x$ .

The polarization state of light can be described using a Stokes vector  $S = [S_0, S_1, S_2, S_3]$ , where  $S_0$  stands for the total light intensity,  $S_1$  and  $S_2$  describe the ratio of the  $0^\circ/45^\circ$  linear polarization over its perpendicular counterpart, and  $S_3$  is the circular polarization power. The Stokes elements  $S_0, S_1, S_2$  can be computed from the measurements  $I_{0^\circ}, I_{45^\circ}, I_{90^\circ}$ , and  $I_{135^\circ}$  as:

$$\begin{aligned} S_0 &= I_{0^\circ} + I_{90^\circ} = I_{45^\circ} + I_{135^\circ}, \\ S_1 &= I_{0^\circ} - I_{90^\circ}, \\ S_2 &= I_{45^\circ} - I_{135^\circ}. \end{aligned} \quad (1)$$

The degree of linear polarization (DoLP) and angle of linear polarization (AoLP) are then formally defined as:

$$\text{DoLP} = \frac{\sqrt{S_1^2 + S_2^2}}{S_0}, \quad \text{AoLP} = \frac{1}{2} \arctan\left(\frac{S_2}{S_1}\right). \quad (2)$$

The type and composition of materials are known to be highly correlated to the DoLP and AoLP observations [4] as illustrated for transparent glass materials in Figure 2. However, this correlation is often challenging to analytically characterize for real-world scenes due to the many factors that contribute to the observations, and a key challenge that we address through the various components that comprise PGSNet (section 4).

We are not the first to consider polarization cues. The use of polarization cues has a rich history in computer vision for a wide range of tasks such as estimating shape and/or surface normals (*e.g.*, [1–3, 6, 16, 33]), reflectance component separation (*e.g.*, [19, 20, 37]), and semantic segmentation (*e.g.*, [17, 39]).

**Transparent Object Segmentation.** The majority of glass object segmentation techniques work on regular RGB images [11, 27, 40, 41, 46]. While these methods have been able to achieve impressive results, RGB images only provide weak glass segmentation cues and the efficacy of these methods is reduced for cluttered scenes and print-out spoofs [17]. To improve robustness, richer records of light-matter interactions have been considered for transparent and semi-transparent object segmentation, such as distortions due to transparency in light-fields [23, 34, 43] and depth information [10, 32]. Despite the richer input sources, these methods still rely on additional assumptions such as weak specular reflections [23, 34, 43], limited object shapes [10], or isolated objects [32], thereby limiting their generality.

Closest related to our work is the glass segmentation network of Kalra *et al.* [17] that takes as input both intensity image as well as polarization cues (*i.e.*, AoLP and

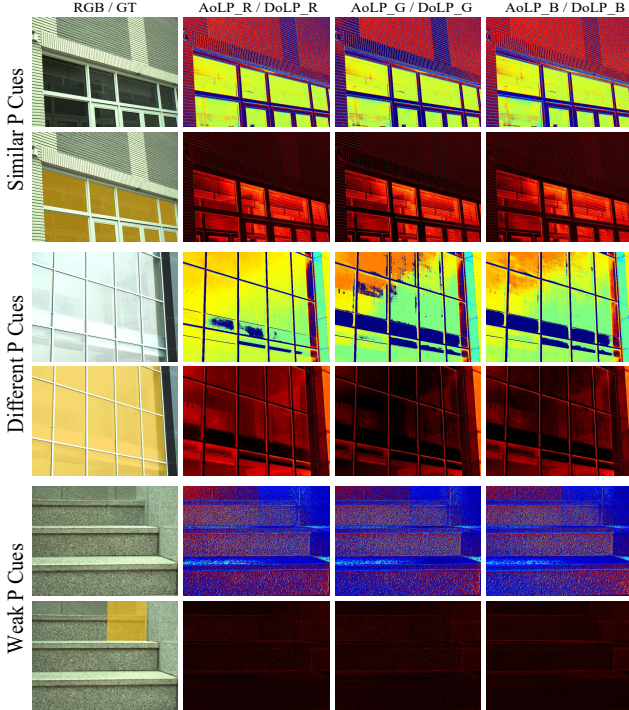
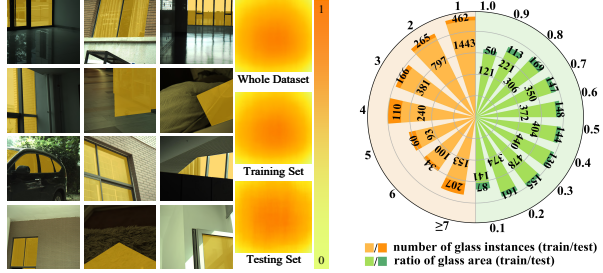

Figure 2. **RGBP-Glass Examples.** For each exemplar we show two rows, with in the first column the RGB intensity (top) and reference glass segmentation (bottom), and in the last three columns the polarization measurements for the red, green, and blue channels, respectively (top: AoLP, bottom: DoLP). The top exemplar exhibits clear glass cues in both RGB and polarization. The middle exemplar features weak intensity cues, but a strong polarization cues in the red channel. The bottom exemplar does not show strong cues in either RGB or polarization.

DoLP). However, Kalra *et al.* focus on robotic bin picking and train their network on a proprietary training set of 1,600 monochromatic images of small transparent objects, ignoring potential wavelength dependent cues embedded in the AoLP and the DoLP. The lack of a large-scale dataset containing in-the-wild transparent objects such as glass walls and windows precludes the exploitation of polarization cues for more general application scenarios. While we also exploit polarization cues, our glass segmentation network (PGSNet) differs in two critical aspects from the method of Kalra *et al.* First, we use trichromatic polarization cues and introduce a publicly-available large-scale RGB-P dataset of in-the-wild transparent objects. Second, whereas Kalra *et al.* only leverage local contextual attention, our method is guided by both global and local contextual attention.

### 3. RGB-P Glass Segmentation Dataset

We collected a large-scale polarization glass segmentation dataset, named *RGBP-Glass* using a trichromatic polarizer-array camera (LUCID PHX050S) that records four different linear-polarization directions ( $0^\circ$ ,  $45^\circ$ ,  $90^\circ$ ,



(a) glass location distribution (b) glass instance/area log distr.

Figure 3. The RGBP-Glass dataset has a wide variation in (a) glass location and (b) number of glass instances and relative size.

Datasets	Segmentation task	Modality		Total Images	Num. Train	Num. Test
		Color	Pol.			
GDD [27]	Glass	RGB	×	3916	2980	936
Trans10K-Stuff [40, 41]	Glass	RGB	×	4226	2455	1771
GSD [21]	Glass	RGB	×	4102	3202	810
ZJU-RGB-P [39]	Semantic	RGB	Tri	394	344	50
Polarized Monochrome [17]	Glass	Gray	Mono	1600	1000	600
<b>RGBP-Glass (Ours)</b>	Glass	RGB	Tri	4511	3207	1304

Table 1. Comparison of existing glass segmentation datasets.

and  $135^\circ$ ) for each color channel (*i.e.*, R, G, and B) at a  $612 \times 512$  resolution per polarization direction. *RGBP-Glass* contains 4,511 RGB intensity and corresponding pixel-aligned trichromatic AoLP and DoLP images with manually annotated pixel-level accurate reference glass-masks and associated bounding-boxes. Each image in *RGBP-Glass* contains at least one in-the-wild glass object. To ensure diversity of scenes, we capture the dataset from different locations, view angles, lighting conditions, types of glass, and shapes of glass. The polarization filter mask of the camera reduces the light efficiency of the sensor, and we compensate for this by using a  $f/1.6$  aperture and manually adjust the exposure time. Table 1 compares *RGBP-Glass* to other similar datasets, and Figure 2 provides representative examples. To avoid overfitting to glass location, object size or number of glass instances, we ensure *RGBP-Glass* covers a wide distribution of glass locations (Figure 3(a)), ratio of glass area (Figure 3(b)), and number of glass instances per image (Figure 3(b)). To the best of our knowledge, *RGBP-Glass* is the most extensive publicly-available RGB-P-based dataset for glass-like object segmentation tasks.

### 4. Spectral-Polarimetric Glass Segmentation

The three selected examples in Figure 2 show that polarization measurements can provide strong additional cues for glass segmentation. However, naively including these measurements in existing glass segmentation networks does not necessarily yield the expected improvement in performance. In typical cases, both RGB and polarization observations provide meaningful cues for glass segmentation (*e.g.*, Figure 2(a)). However, under certain light conditions

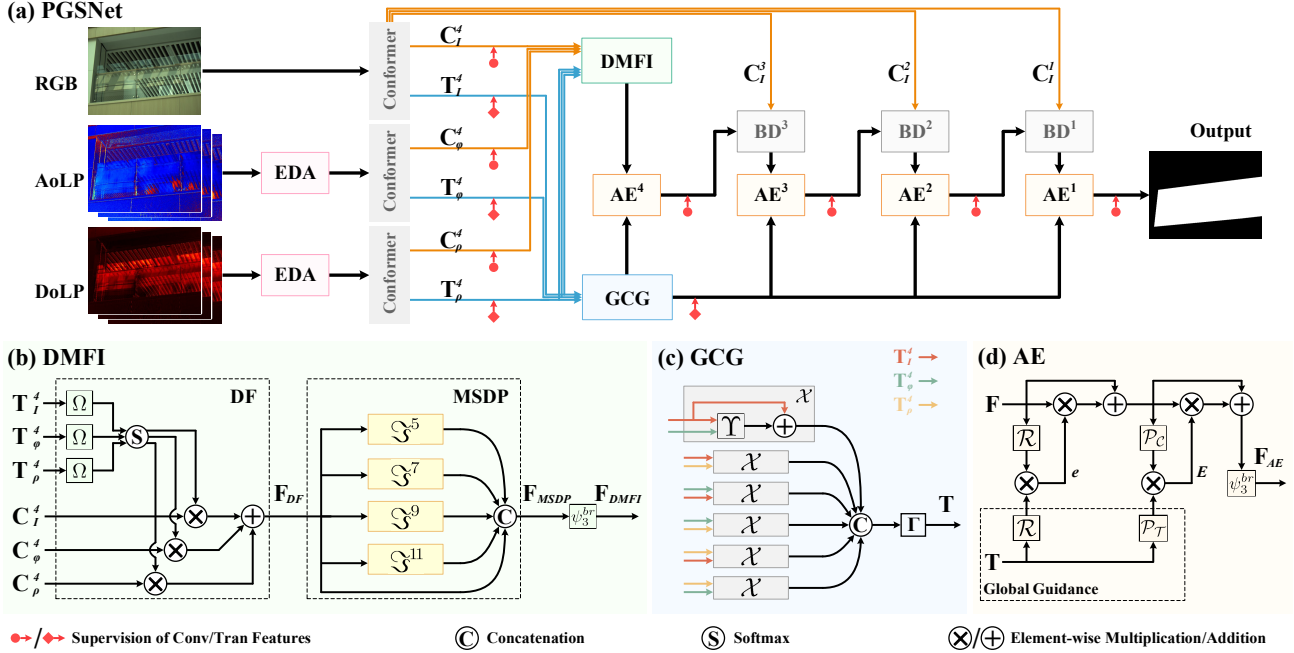

Figure 4. Overview of PGSNet (a) and the three main building blocks: (b) the Dynamic Multimodal Feature Integration (DMFI) module, (c) the Global Context Generation (GCG) module, and (d) an Attention Enhancement (AE) module.

and/or view angles, the polarization cues may be weak or even non-existent, providing no meaningful cues for segmentation (e.g., Figure 2(c)). Similarly, under adverse conditions (e.g., fog), RGB intensities might not provide meaningful cues either. Furthermore, even within a modality, the cues provided by the different color channels might not be equally important (e.g., Figure 3(b)), or even provide contradictory cues. Effectively and dynamically fusing *between* and *within* the multimodal cues is essential for robust multimodal glass segmentation.

We introduce a novel Polarization Glass Segmentation Network (PGSNet) that aims to dynamically fuse multimodal intensity and polarization measurements for robust segmentation by leveraging both local and global contextual information. PGSNet follows an encoder-decoder architecture, summarized in Figure 4(a). During encoding, an early dynamic attention module (EDA; subsection 4.1) estimates global scaling weights for balancing the different color channels within each of the trichromatic AoLP and DoLP. Next, the weighted trichromatic AoLP and DoLP along with the RGB intensity image are passed into three separate Conformer [31] branches for feature extraction. The goal of the Conformer stage is to balance differences between glass and non-glass objects within each of the different sources. For example, if there is no or little polarization observed on glass-like objects, then PGSNet should leverage any potential global and local contextual information between glass and non-glass objects in the polarization cues. In the final encoding step, we employ a novel

Dynamic Multimodal Feature Integration (DMFI) module (subsection 4.2) to dynamically fuse together the extracted local features from the three input sources (i.e., RGB, AoLP, and DoLP) guided by the global features.

During decoding, we rely on the global contextual cues to avoid over-segmentation. To avoid diluting global context features with subsequent steps in the decoding pipeline, we introduce a novel Global Context Guided Decoder (GCGD; subsection 4.3) that employs an Attention Enhancement (AE) module to dynamically provide global guidance based on the multimodal global features from the three Conformer branches.

#### 4.1. Early Dynamic Attention (EDA)

The purpose of the EDA module is to estimate global weight factors to balance the color channels in the AoLP and DoLP measurements. We employ a ResNet-18 [13] (with shared weights between color channels) followed by a fully connected layer and a SoftMax operator to estimate appropriate weights for each of the color channels. Formally, the EDA module can be denoted as:

$$w_r, w_g, w_b = \sigma(\langle G(p_r), G(p_g), G(p_b) \rangle),$$

$$P = [w_r p_r, w_g p_g, w_b p_b], \quad (3)$$

where  $p_{\{r,g,b\}}$  are the red, green, or blue polarization measurements (AoLP or DoLP) with weights  $w_{\{r,g,b\}}$  respectively;  $[\cdot, \cdot, \cdot]$  indicates the concatenation operation over the channel dimension;  $\sigma$  is the SoftMax function;  $\langle \cdot, \cdot, \cdot \rangle$  denotes a vector; and  $G$  is the weight estimation network.

## 4.2. Dynamic Multimodal Feature Integration (DMFI)

The importance of the cues gathered from the different modalities (*i.e.*, RGB intensity, AoLP, and DoLP), is scene-dependent (cf. Figure 2). A naive combination of these cues can dilute the impact of strong cues with weak signals, or even amplify adverse effects of confounding cues. A Dynamic Multimodal Feature Integration (DMFI) addresses the robust fusing of features from the three input domains by leveraging global and local information. The DMFI module, illustrated in Figure 4(b), consists of two blocks: a Dynamic Fusion (DF) block and a Multi-Scale Dependency Perception (MSDP) block.

**Dynamic Fusion (DF).** The DF block first generates three spatial attention maps on the three sequences of token embeddings provided by three Conformers [31] for each of the three input modalities (see the supplemental material for details on Conformers). The extracted convolution features are subsequently weighted by the attention maps and fused (summer) together:

$$M_I^4, M_\phi^4, M_\rho^4 = \sigma(\langle \Omega(T_I^4), \Omega(T_\phi^4), \Omega(T_\rho^4) \rangle),$$

$$F_{DF} = M_I^4 \otimes C_I^4 + M_\phi^4 \otimes C_\phi^4 + M_\rho^4 \otimes C_\rho^4, \quad (4)$$

where  $M$  are the attention maps generated from  $I$ ,  $\phi$ , and  $\rho$ , the RGB intensity, AoLP, and DoLP input respectively, and  $\Omega$  is a function that first reduces the dimensions of every token embedding to one via a fully connected layer, and then subsequently reshapes the resulting embedding to a 2D map.  $C$  and  $T$  are the convolution features and token embeddings generated by the *conv* and the *trans* branch in the Conformer [31], respectively, where the superscript denotes the index of Conformer’s internal block, and  $\otimes$  is the element-wise multiplication.

**Multi-Scale Dependency Perception (MSDP).** To reduce the impact of shape variations and locations of the glass objects, the MSDP block enhances the global dependencies for locating glass objects in the dynamically fused feature  $F_{DF}$  using a specially designed multi-scale self-attention mechanism. By varying the perceptive scales, the MSDP block can effectively detect correlations between regions at different scales. Formally:

$$F_V = \psi_3^{br}(F_{DF}),$$

$$F_{DP}^n = \mathfrak{S}^n(F_V) = F_V + \alpha * \mathcal{U}(\mathcal{N}(\mathcal{A}^n(F_V))),$$

$$F_{MSDP} = [F_{DF}, F_{DP}^5, F_{DP}^7, F_{DP}^9, F_{DP}^{11}], \quad (5)$$

where  $\psi_k^{br}$  is a  $k \times k$  convolution layer followed by a Batch Normalization (BN) and ReLU activation function.  $\mathcal{A}^n$  is an adaptive average pooling with target size  $n \times n$ ,  $\mathcal{U}$  is a bilinear upsampling, and  $\alpha$  is a learnable parameter.  $\mathcal{N}(x)$  is the self-attention operation defined as

$\mathcal{V}(x)(\sigma(\mathcal{K}(x)^T \mathcal{Q}(x)))$ ;  $\mathcal{Q}$ ,  $\mathcal{K}$ , and  $\mathcal{V}$  are three learnable linear embedding functions, implemented as three fully connected layers. Our MSDP block is similar to existing attention schemes (*e.g.*, PPM [47], ASPP [5] non-local attention [35]). We refer to the supplementary material for additional experiments validating that MSDP outperforms prior schemes.

The final output of the DMFI block applies an additional  $3 \times 3$  convolution to the output features of the MSDP block:  $F_{DMFI} = \psi_3^{br}(F_{MSDP})$ .

## 4.3. Global Context Guided Decoder (GCGD)

Global contextual cues are essential to avoid over-segmentation during the decoding phase. Typically, these global contextual cues are injected in the decoder via the high-level features. However, as the decoding process proceeds to lower-level features, the influence of the global contextual features dilutes. To retain the global contextual information during the decoding process, we introduce a novel Global Context Guided Decoder (GCGD) that consists of a Global Context Generation (GCG) module (Figure 4(c)) that forms global guidance cues across the three input domains, and an Attention Enhancement (AE) module (Figure 4(d)) that leverages these global guidance cues to enhance the low-level features.

**Global Context Generation (GCG).** Key to the GCG is the observation that the token embeddings  $T_I^4$ ,  $T_\phi^4$ , and  $T_\rho^4$  from the Conformers [31] are inherently global-aware characteristics. We leverage these token embeddings by first computing a set of cross-correlation features:

$$F_{xy} = \mathcal{X}(T_x^4, T_y^4),$$

$$= T_x^4 + \Upsilon(T_x^4, T_y^4),$$

$$= T_x^4 + \varsigma(\mathcal{Q}(T_y^4) \mathcal{K}(T_x^4)^T / \sqrt{d}) \mathcal{V}(T_x^4), \quad (6)$$

where  $xy \in \{I\phi, I\rho, \phi I, \phi\rho, \rho I, \rho\phi\}$ ,  $\varsigma$  is the sigmoid function, and  $d$  denotes the length of a token embedding. These cross-correlation features are then combined via a linear projection  $\Gamma$ , implemented by a fully connected layer:

$$T = \Gamma([F_{I\phi}, F_{I\rho}, F_{\phi I}, F_{\phi\rho}, F_{\rho I}, F_{\rho\phi}]). \quad (7)$$

**Attention Enhancement (AE).** The AE utilizes the combined features from the GCG module to enhance the input features by computing and combining a spatial enhancement map  $E$  and channel features  $e$ . In the GCGD, we deploy four AE blocks, and the decoder features go through the 4th AE block first. Mathematically, the  $j$ -th AE block is defined as:

$$e^j = \mathcal{R}(F^j) * \mathcal{R}(T_g)$$

$$E^j = \mathcal{P}_C(F^{j'}) * \mathcal{P}_T(t_s, T_g),$$

$$F^{j''} = F^{j'} * E^j + F^{j'}, \quad F^{j'} = F^j * e^j + F^j,$$

$$F_{AE}^j = \psi_3^{br}(F^{j''}) \quad j \in [1, 4], \quad (8)$$

where  $F^4 = F_{DMFI}$  and  $F^i = F_{BD}^i = \psi_3^{br}(C_I^i + \mathcal{U}(\psi_3^{br}(F_{AE}^{i+1})))$ ,  $i \in [1, 3]$ .  $\mathcal{R}(x)$  is the channel feature generator defined as  $\varsigma(\psi_1(\psi_1^{br}(\mathcal{A}^1(x))))$ ;  $\mathcal{P}_C(x)$  is a spatial map generator based on convolution features, defined as  $\varsigma(\psi_7(x))$ ; and  $\mathcal{P}_T(x, y)$  is also a spatial map generator but based on token embeddings, defined as  $\varsigma(\Omega(y + \Upsilon(x, y)))$ .  $T_g$  and  $t_s$  are  $n$  glass and segmentation tokens in  $T$ .

#### 4.4. Loss Function

We supervise both the encoder and decoder during training. For the encoder, we follow the training process for Conformers [31], and apply two loss functions,  $\mathcal{L}_m^C$  and  $\mathcal{L}_m^T$ , for the *conv* and the *trans*-branches:

$$\mathcal{L}_E = \sum_m (\mathcal{L}_m^C + \mathcal{L}_m^T), m \in \{I, \phi, \rho\}, \quad (9)$$

where  $\mathcal{L}_m^C$  and  $\mathcal{L}_m^T$  are both the sum of a binary cross-entropy (BCE) loss  $\ell_{bce}$  and a IoU loss  $\ell_{iou}$  [25].

For the decoder, we apply supervision on the features generated by the deepest three AE modules and the features generated by the GCG module:

$$\mathcal{L}_D = \sum_{i=2}^4 (\mathcal{L}_{AE}^i) + \mathcal{L}_{GCG}, \quad (10)$$

where the losses on the AE modules and the GCG module are computed again as:  $\ell_{bce} + \ell_{iou}$ . Finally, we combine the losses for both the encoder  $\mathcal{L}_E$  and decoder  $\mathcal{L}_D$  with the BCE and IoU loss on the final output mask. To promote clear mask boundaries, we also add an edge loss  $\ell_{edge}$  [48] (weighted by  $\omega = 10$  empirically determined):

$$\mathcal{L} = \mathcal{L}_E + \mathcal{L}_D + \ell_{bce} + \ell_{iou} + \omega \ell_{edge}, \quad (11)$$

### 5. Assessment

We implemented PGSNet in PyTorch [30] and train our network for 180 epochs with a batch size of 18 using stochastic gradient descent with a momentum of 0.9 and a weight decay of  $5 \times 10^{-4}$ . We employ the poly strategy [22] and set the initial learning rate and power to 0.001 and 0.9, respectively. We initialize PGSNet randomly, except EDA which is initialized with ResNet-18 [13] and the Conformer-B model [31] which is initialized with a model pre-trained on ImageNet. All input images are resized to  $416 \times 416$  for both training and testing, and the final output is bilinearly resized back to the original input resolution.

We use four metrics for validation and ablation: intersection over union (*IoU*), weighted F-measure ( $F_\beta^w$ ) [24], mean absolute error (*MAE*), and balance error rate (*BER*) [28]. For *IoU* and  $F_\beta^w$ , higher is better, while for *MAE* and *BER*, lower is better. We refer to the supplementary materials for a formal definition of each metric.

#### 5.1. Qualitative and Quantitative Evaluation

We extensively compare the effectiveness of our method to 22 state-of-the-art methods across different related tasks

Methods	IoU $\uparrow$	$F_\beta^w\uparrow$	MAE $\downarrow$	BER $\downarrow$
Mask R-CNN $^\circ$ [12]	63.59	0.677	0.224	22.62
PSPNet $^\circ$ [47]	74.49	0.786	0.128	14.76
DenseASPP $^\circ$ [44]	75.18	0.793	0.119	14.28
DANet $^\circ$ [9]	75.64	0.793	0.121	14.15
CCNet $^\circ$ [15]	76.52	0.799	<b>0.117</b>	13.44
SETR $^\circ$ [49]	77.60	<b>0.817</b>	<b>0.114</b>	<b>11.46</b>
SegFormer $^\circ$ [42]	<b>78.42</b>	<b>0.815</b>	0.121	13.03
DSS $^\Delta$ [14]	69.32	0.707	0.183	17.33
CPD $^\Delta$ [38]	75.60	0.790	0.127	13.25
F3Net $^\Delta$ [36]	73.03	0.764	0.146	14.92
MINet-R $^\Delta$ [29]	70.56	0.746	0.147	15.92
PFNet $^\nabla$ [26]	76.26	0.790	0.130	12.83
SINet-V2 $^\nabla$ [7]	76.86	0.796	0.126	12.76
PraNet $^\S$ [8]	75.45	0.781	0.133	13.80
BDRAR $^{*\dagger}$ [50]	69.13	0.732	0.173	18.68
MirrorNet $^{*\dagger}$ [45]	76.49	0.796	0.126	13.52
GDNet $^*$ [27]	77.64	0.807	0.119	<b>11.79</b>
TransLab $^*$ [40]	73.59	0.772	0.148	15.73
Trans2Seg $^*$ [41]	75.21	0.799	0.122	13.23
GSD $^{*\dagger}$ [21]	<b>78.11</b>	0.806	0.122	12.61
EAFNet $^\diamond$ [39]	53.86	0.611	0.237	24.65
P Mask R-CNN $^*$ [17]	66.03	0.714	0.178	18.92
<b>PGSNet (Ours)</b>	<b>81.08</b>	<b>0.842</b>	<b>0.091</b>	<b>9.63</b>
<i>PGSNet ([39] data)</i>	77.70	0.839	0.007	6.92

Table 2. Quantitative comparison against state-of-the-art: instance/semantic segmentation methods (marked by the  $\circ$  symbol), salient object detection methods ( $\Delta$ ), camouflaged object segmentation methods ( $\nabla$ ), medical image segmentation method ( $\S$ ), shadow detection method ( $\bullet$ ), mirror segmentation method ( $\times$ ), RGB glass segmentation methods ( $*$ ), RGB+P semantic segmentation method ( $\diamond$ ), monochromatic intensity, and polarization-based glass segmentation methods ( $\star$ ). All methods are retrained and tested on the RGBP-Glass dataset (excl. the last row which demonstrates that PGSNet generalize to other datasets). Methods that require an additional CRF [18] post-processing step are marked with the  $\dagger$  symbol. The first, second, and third best results are highlighted in **red**, **green**, and **blue**, respectively.

such as instance/semantic, salient/camouflaged objects, shadow/mirror segmentation, and glass region/instance segmentation (Table 2). For a fair comparison, all methods are *re-trained* and tested on the RGB-P Glass segmentation dataset. Of the compared methods, EAFNet [39] and P Mask R-CNN [17] are the only two that also leverage polarization cues. GDNet [27], TransLab [40], Trans2Seg [41], and GSD [21] are in-the-wild glass segmentation methods, but only rely on RGB intensity input. From Table 2 we can see that the proposed method offers the best performance for all four metrics, outperforming the other competing methods by a significant margin. The two polarization-based approaches, P Mask R-CNN [17] and EAFNet [39], do not perform well. P Mask R-CNN [17] extends Mask R-CNN [12] with a cross-domain attention scheme. Mask R-CNN work well on small objects, as is the case for Kalra *et al.*'s intended task of robotic bin picking, but its performance suffers when segmenting larger objects, even when including polarization cues. Furthermore, P Mask R-CNN

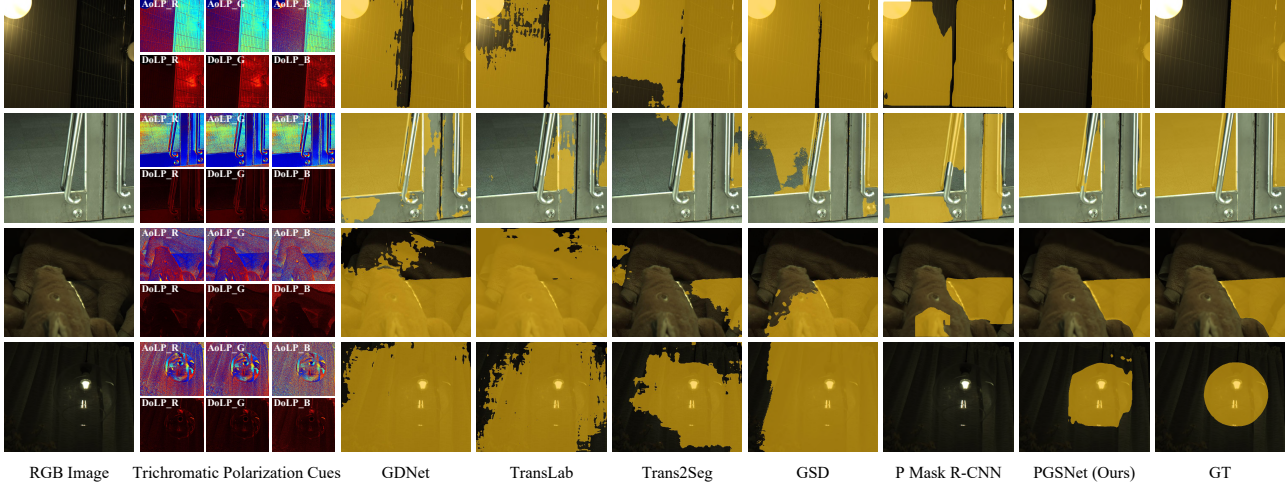

Figure 5. Qualitative comparison of PGSNet against state-of-the-art glass segmentation methods retrained on the RGBP-Glass dataset.

only uses monochromatic cues for both intensity and polarization, which is less effective than using trichromatic cues. While EAFNet [39] also explored multichromatic DoLP and AoLP, Xiang *et al.* concluded that EAF-A (*i.e.*, RGB+ AoLP) performs best for *semantic* segmentation with EAFNet, and in our comparisons we follow this approach. However, as our ablation study will show (subsection 5.2), the DoLP is more informative than AoLP for *glass* segmentation. The lower accuracy of EAFNet is partially because it is designed to solve a more general problem (semantic vs. glass segmentation) and partially because it places a higher emphasis on performance than PGSNet. We refer to the supplemental material for a performance comparison. Finally, we also trained and tested PGSNet on the smaller ZJU-RGB-P dataset (last row of Table 2), demonstrating that PGSNet generalizes well to other datasets with similar performance gains. Figure 5 further qualitatively demonstrates the benefits of our method:

1. The reflections in the glass in the **bathroom scene** share the same texture as the wall. Only our method is able to accurately segment the glass. The monochromatic polarization information leveraged by P Mask R-CNN as well as the employed fusion scheme are not powerful enough to successfully segment the glass.
2. **Glass in metal door-frame**: all methods except PGSNet and Trans2Seg confuse the metal material for glass. Trans2Seg’s glass segmentation is less accurate than our method’s result which leverages both the strong polarization cues as well as global contextual information to achieve the best performance.
3. In the 3rd and 4th example, even though the **glass is invisible in the RGB intensity image**, we still observe strong AoLP and DoLP cues. Despite also leveraging polarization cues, P Mask R-CNN fails on the 4th example. In contrast, our method succeeds thanks to our dynamic context-aware attention-based fusion.

## 5.2. Ablation Study

Next, we investigate (a) the impact of spectral polarization cues and (b) influence of each component in PGSNet. For each experiment we fully retrain each model.

**Impact of Spectral Polarization Cues.** We conduct a series of ablation experiments to demonstrate the effects of spectral polarization cues on glass segmentation Table 3: (A) PGSNet baseline; (B) with RGB intensity cues only; (C) with AoLP, but without DoLP; (D) with DoLP, but without AoLP; (E) monochromatic intensity plus monochromatic polarization cues; and (F) RGB intensity cues with *monochromatic* polarization cues. Comparing B (RGB only) with C, D, or F, we can see that adding any form of polarization cues to the RGB intensity cues improves the segmentation accuracy. Furthermore, we observe that DoLP cues (D) have a greater impact than AoLP cues (C). In contrast to the findings by Kalra *et al.* [17], the differences between E and F indicate that spectral RGB intensity information has a major impact. Finally, the differences between our baseline (A) and (F) further demonstrates that spectral polarization cues are more informative than monochromatic polarization cues. Figure 6 visually supports the above quantitative observations.

**Influence of Early Dynamic Attention (EDA).** The EDA module balances the different spectral components in both the DoLP and AoLP. Comparing Table 3 A (with EDA) versus G (without EDA) shows significant performance gain when including EDA, validating the dynamically balancing the contributions of each wavelength.

**Influence of PGSNet Components.** We demonstrate the influence and importance of each of the components that comprise PGSNet by gradually removing different components. First, we ablate the decoder by removing the GCG from the GCGD (Table 3 H) which results in a reduction in performance compared to the baseline (Table 3 A). Next,

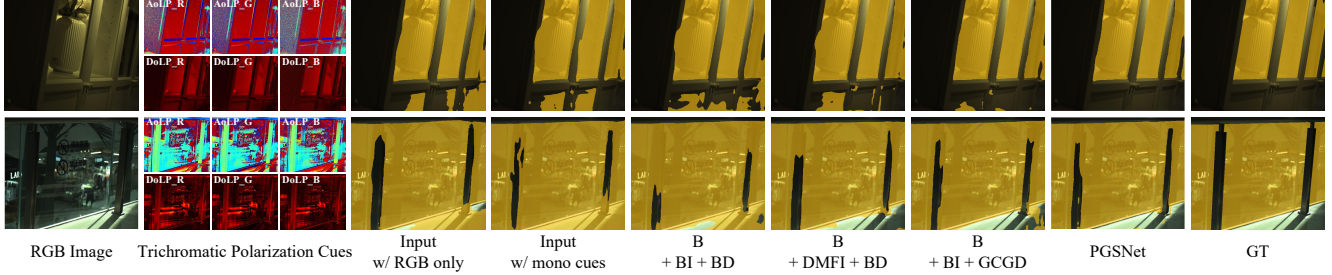

Figure 6. Qualitative comparison of different PGSNet ablatives.

Networks	RGBP-Glass Testing Set			
	IoU $\uparrow$	$F\beta^w\uparrow$	MAE $\downarrow$	BER $\downarrow$
<i>A</i> PGSNet (original)	<b>81.08</b>	<b>0.842</b>	<b>0.091</b>	<b>9.63</b>
<i>B</i> Input RGB only	76.11	0.797	0.126	13.08
<i>C</i> Input RGB + trichromatic AoLP	77.23	0.807	0.117	12.04
<i>D</i> Input RGB + trichromatic DoLP	79.73	0.826	0.105	10.46
<i>E</i> Input Gray + Mono AoLP + Mono DoLP	75.99	0.793	0.123	12.75
<i>F</i> Input RGB + Mono AoLP + Mono DoLP	79.01	0.819	0.105	11.06
<i>G</i> PGSNet w/o EDA	80.23	0.833	0.097	10.04
<i>H</i> B + DMFI + GCGD w/o GCG	79.64	0.826	0.102	10.35
<i>I</i> B + DMFI + BD	79.18	0.824	0.103	10.73
<i>J</i> B + DMFI w/o MSDP + BD	78.65	0.819	0.106	11.09
<i>K</i> B + BI + GCGD	79.03	0.821	0.104	10.82
<i>L</i> B + BI + BD	77.24	0.809	0.111	11.35

Table 3. Quantitative ablation comparisons showing that: a) spectral and polarization cues promote more robust glass segmentation, and b) all component of PGSNet contributes to the overall performance. We denote the backbone network (EDA + Conformer) with ‘B’, where ‘EDA’ is the Early Dynamic Attention module. ‘BI’ denotes a basic integration unit (*i.e.*, element-wise addition), used for ablating the Dynamic Multimodal Feature Integration (DMFI) module, and ‘BD’ denotes a Basic Decoder used to ablate the Global Context Generation (‘GCG’) module.

we remove the four AE blocks and replace the GCGD by a basic decoder (BD) further reducing performance (*I*). On the encoder side, we then simplify the DMFI module by removing the MSDP block (*J*). Adding back the full GCGD, but exchanging the DMFI by a basic integration module (BI) that sets all values in the attention map  $M_x^4, x \in \{I, \phi, \rho\}$  to 1 in Equation 4, yields an improvement (*K* vs. *J*), but is still slightly below the full integration module with a basic decoder (*I*). This shows that both components (GCGD and DMFI) contribute to the overall performance of PGSNet. Comparing *I* (2nd best) versus *J* (2nd worst) demonstrates the importance of using multi-scale dependencies. Finally, we replace all components by their basic counterpart, yielding a worst performance (*L*), illustrating the importance of each component in PGSNet.

### 5.3. Limitations

When polarization only provides weak or no cues, the effectiveness of our method decreases; Figure 7 demonstrates such a case. However, even without polarization

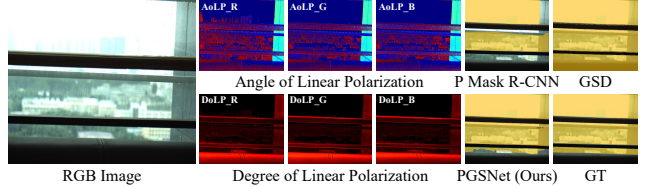

Figure 7. PGSNet’s effectiveness is reduced for scenes with weak polarization cues.

cues, our method (Table 3 *B*) still performs well compared to prior glass segmentation methods. Even with RGB only input, our method still outperforms existing glass segmentation methods that leverage polarization cues. In addition, PGSNet expects at least one glass object in the photograph, and it fails when no such object is present. Note that this can be resolved by training on RGBP-Glass augmented with images without glass objects from ZJU-RGB-P [39].

## 6. Conclusion

In this paper we presented a robust glass segmentation network, PGSNet, to dynamically fuse trichromatic intensity and polarization cues recorded in-the-wild. The proposed network includes several novel modules. On the encoder side, a DMFI module integrates multimodal trichromatic measurements by leveraging multi-scale pixel-wise dependencies to dynamically enhance local contextual cues. On the decoder side, a novel GCGD leverages cross-modal global contextual information to provide robust segmentation. To promote polarization as a valuable cue for vision tasks, we also introduce a large-scale RGBP-Glass dataset that we also use to train PGSNet. Our validation and ablations demonstrate the value of trichromatic polarization cues as well as the effectiveness and robustness of PGSNet.

**Acknowledgments.** This work was supported by the National Natural Science Foundation of China under Grant 61972067/U21A20491/U1908214, National Key Research and Development Program of China (2021ZD0112400), and the Innovation Technology Funding of Dalian (2020JJ26GX036). Pieter Peers was supported by NSF grant IIS-1909028. Felix Heide was supported by an NSF CAREER Award (2047359), a Sony Young Faculty Award, and a Project X Innovation Award.



## References

- [1] G.A. Atkinson and E.R. Hancock. Multi-view surface reconstruction using polarization. In *ICCV*, 2005. 2
- [2] G.A. Atkinson and E.R. Hancock. Recovery of surface orientation from diffuse polarization. *IEEE TIP*, 2006. 2
- [3] Gary A Atkinson and Edwin R Hancock. Two-dimensional brdf estimation from polarisation. *CVIU*, 2008. 2
- [4] Seung-Hwan Baek, Tizian Zeltner, Hyunjin Ku, Inseung Hwang, Xin Tong, Wenzel Jakob, and Min H Kim. Image-based acquisition and modeling of polarimetric reflectance. *ACM TOG*, 2020. 2
- [5] Liang-Chieh Chen, George Papandreou, Iasonas Kokkinos, Kevin Murphy, and Alan L Yuille. Deeplab: Semantic image segmentation with deep convolutional nets, atrous convolution, and fully connected crfs. *IEEE TPAMI*, 2017. 5
- [6] Tongbo Chen, Hendrik P. A. Lensch, Christian Fuchs, and Hans-Peter Seidel. Polarization and phase-shifting for 3d scanning of translucent objects. In *CVPR*, 2007. 2
- [7] Deng-Ping Fan, Ge-Peng Ji, Ming-Ming Cheng, and Ling Shao. Concealed object detection. *IEEE TPAMI*, 2021. 6
- [8] Deng-Ping Fan, Ge-Peng Ji, Tao Zhou, Geng Chen, Huazhu Fu, Jianbing Shen, and Ling Shao. Pranet: Parallel reverse attention network for polyp segmentation. *MICCAI*, 2020. 6
- [9] Jun Fu, Jing Liu, Haijie Tian, Yong Li, Yongjun Bao, Zhiwei Fang, and Hanqing Lu. Dual attention network for scene segmentation. In *CVPR*, 2019. 6
- [10] Chen Guo-Hua, Wang Jun-Yi, and Zhang Ai-Jun. Transparent object detection and location based on rgb-d camera. *Journal of Physics: Conference Series*, 2019. 2
- [11] Hao He, Xiangtai Li, Guangliang Cheng, Jianping Shi, Yunhai Tong, Gaofeng Meng, Veronique Prinnet, and LuBin Weng. Enhanced boundary learning for glass-like object segmentation. In *ICCV*, 2021. 1, 2
- [12] Kaiming He, Georgia Gkioxari, Piotr Dollar, and Ross Girshick. Mask r-cnn. In *ICCV*, 2017. 6
- [13] Kaiming He, Xiangyu Zhang, Shaoqing Ren, and Jian Sun. Deep residual learning for image recognition. In *CVPR*, 2016. 4, 6
- [14] Qibin Hou, Ming-Ming Cheng, Xiaowei Hu, Ali Borji, Zhuowen Tu, and Philip Torr. Deeply supervised salient object detection with short connections. *IEEE TPAMI*, 2019. 6
- [15] Zilong Huang, Xinggang Wang, Lichao Huang, Chang Huang, Yunchao Wei, and Wenyu Liu. Ccnet: Criss-cross attention for semantic segmentation. In *ICCV*, 2019. 6
- [16] Achuta Kadambi, Vage Taamazyan, Boxin Shi, and Ramesh Raskar. Polarized 3d: High-quality depth sensing with polarization cues. In *ICCV*, 2015. 2
- [17] Agastya Kalra, Vage Taamazyan, Supreeth Krishna Rao, Kartik Venkataraman, Ramesh Raskar, and Achuta Kadambi. Deep polarization cues for transparent object segmentation. In *CVPR*, 2020. 1, 2, 3, 6, 7
- [18] Philipp Krähenbühl and Vladlen Koltun. Efficient inference in fully connected crfs with gaussian edge potentials. In *NeurIPS*, 2011. 6
- [19] Chenyang Lei, Xuhua Huang, Mengdi Zhang, Qiong Yan, Wenxiu Sun, and Qifeng Chen. Polarized reflection removal with perfect alignment in the wild. In *CVPR*, 2020. 1, 2
- [20] Rui Li, Simeng Qiu, Guangming Zang, and Wolfgang Heidrich. Reflection separation via multi-bounce polarization state tracing. In *ECCV*, 2020. 1, 2
- [21] Jiaying Lin, Zebang He, and Rynson W.H. Lau. Rich context aggregation with reflection prior for glass surface detection. In *CVPR*, 2021. 1, 3, 6
- [22] Wei Liu, Andrew Rabinovich, and Alexander C. Berg. Parsenet: Looking wider to see better. *arXiv*, 2015. 6
- [23] Kazuki Maeno, Hajime Nagahara, Atsushi Shimada, and Rin-Ichiro Taniguchi. Light field distortion feature for transparent object recognition. In *CVPR*, 2013. 1, 2
- [24] Ran Margolin, Lihi Zelnik-Manor, and Ayellet Tal. How to evaluate foreground maps? In *CVPR*, 2014. 6
- [25] Gellért Mátyus, Wenjie Luo, and Raquel Urtasun. Deep-roadmapper: Extracting road topology from aerial images. In *ICCV*, 2017. 6
- [26] Haiyang Mei, Gepeng Ji, Ziqi Wei, Xin Yang, Xiaopeng Wei, and Dengping Fan. Camouflaged object segmentation with distraction mining. In *CVPR*, 2021. 6
- [27] Haiyang Mei, Xin Yang, Yang Wang, Yuanyuan Liu, Shengfeng He, Qiang Zhang, Xiaopeng Wei, and Rynson W.H. Lau. Don't hit me! glass detection in real-world scenes. In *CVPR*, 2020. 1, 2, 3, 6
- [28] Vu Nguyen, Tomas F Yago Vicente, Maozheng Zhao, Minh Hoai, and Dimitris Samaras. Shadow detection with conditional generative adversarial networks. In *ICCV*, 2017. 6
- [29] Youwei Pang, Xiaoqi Zhao, Lihe Zhang, and Huchuan Lu. Multi-scale interactive network for salient object detection. In *CVPR*, 2020. 6
- [30] Adam Paszke, Sam Gross, Francisco Massa, Adam Lerer, James Bradbury, Gregory Chanan, Trevor Killeen, Zeming Lin, Natalia Gimelshein, Luca Antiga, et al. Pytorch: An imperative style, high-performance deep learning library. In *NeurIPS*, 2019. 6
- [31] Zhiliang Peng, Wei Huang, Shanzhi Gu, Lingxi Xie, Yaowei Wang, Jianbin Jiao, and Qixiang Ye. Conformer: Local features coupling global representations for visual recognition. In *ICCV*, 2021. 2, 4, 5, 6
- [32] Viktor Seib, Andreas Barthen, Philipp Marohn, and Dietrich Paulus. Friend or foe: exploiting sensor failures for transparent object localization and classification. In *ICRMV*, 2017. 2
- [33] Vimal Thilak, David G. Voelz, and Charles D. Creusere. Polarization-based index of refraction and reflection angle estimation for remote sensing applications. *Applied Optics*, 2007. 2
- [34] Dorian Tsai, Donald G. Dansereau, Thierry Peynot, and Peter Corke. Distinguishing refracted features using light field cameras with application to structure from motion. *IEEE Robotics and Automation Letters*, 2019. 1, 2
- [35] Xiaolong Wang, Ross Girshick, Abhinav Gupta, and Kaiming He. Non-local neural networks. In *CVPR*, 2018. 5
- [36] Jun Wei, Shuhui Wang, and Qingming Huang. F3net: Fusion, feedback and focus for salient object detection. *AAAI*, 2020. 6

- [37] Patrick Wieschollek, Orazio Gallo, Jinwei Gu, and Jan Kautz. Separating reflection and transmission images in the wild. In *ECCV*, 2018. 1, 2
- [38] Zhe Wu, Li Su, and Qingming Huang. Cascaded partial decoder for fast and accurate salient object detection. In *CVPR*, 2019. 6
- [39] Kaite Xiang, Kailun Yang, and Kaiwei Wang. Polarization-driven semantic segmentation via efficient attention-bridged fusion. *Optics Express*, 2021. 1, 2, 3, 6, 7, 8
- [40] Enze Xie, Wenjia Wang, Wenhai Wang, Mingyu Ding, Chunhua Shen, and Ping Luo. Segmenting transparent objects in the wild. In *ECCV*, 2020. 1, 2, 3, 6
- [41] Enze Xie, Wenjia Wang, Wenhai Wang, Peize Sun, Hang Xu, Ding Liang, and Ping Luo. Segmenting transparent object in the wild with transformer. In *IJCAI*, 2021. 1, 2, 3, 6
- [42] Enze Xie, Wenhai Wang, Zhiding Yu, Anima Anandkumar, Jose M Alvarez, and Ping Luo. Segformer: Simple and efficient design for semantic segmentation with transformers. *NeurIPS*, 2021. 6
- [43] Yichao Xu, Hajime Nagahara, Atsushi Shimada, and Rintaro Taniguchi. Transcut: Transparent object segmentation from a light-field image. In *ICCV*, 2015. 1, 2
- [44] Maoke Yang, Kun Yu, Chi Zhang, Zhiwei Li, and Kuiyuan Yang. Denseaspp for semantic segmentation in street scenes. In *CVPR*, 2018. 6
- [45] Xin Yang, Haiyang Mei, Ke Xu, Xiaopeng Wei, Baocai Yin, and Rynson W.H. Lau. Where is my mirror? In *ICCV*, 2019. 6
- [46] Letian Yu, Haiyang Mei, Wen Dong, Ziqi Wei, Li Zhu, Yuxin Wang, and Xin Yang. Progressive glass segmentation. *IEEE TIP*, 2022. 2
- [47] Hengshuang Zhao, Jianping Shi, Xiaojuan Qi, Xiaogang Wang, and Jiaya Jia. Pyramid scene parsing network. In *CVPR*, 2017. 5, 6
- [48] Ting Zhao and Xiangqian Wu. Pyramid feature attention network for saliency detection. In *CVPR*, 2019. 6
- [49] Sixiao Zheng, Jiachen Lu, Hengshuang Zhao, Xiatian Zhu, Zekun Luo, Yabiao Wang, Yanwei Fu, Jianfeng Feng, Tao Xiang, Philip H.S. Torr, and Li Zhang. Rethinking semantic segmentation from a sequence-to-sequence perspective with transformers. In *CVPR*, 2021. 6
- [50] Lei Zhu, Zijun Deng, Xiaowei Hu, Chi-Wing Fu, Xuemiao Xu, Jing Qin, and Pheng-Ann Heng. Bidirectional feature pyramid network with recurrent attention residual modules for shadow detection. In *ECCV*, 2018. 6